

LABEL1

Product number/revision
Serial number

PCBA Label

PCB

A08-2356
ATmega328PB-XMINI PCB

PCBA Documentation

PCBADOC1
A12-1030

TESTDOC1
A12-0853

FW1
A11-0252

TEST1
A11-0312

ATMEL Norway	*	<p style="font-size: small;">Enabling Unlimited Possibilities</p>	
Vestre Rosten 79	*		
N-7075 TILLER	*		
NORWAY			
Date:	5/6/2015	10:19:57 PM	PAGE: 1 of 3
Document number:	A12-1030	Revision	3
TITLE: ATmega328PB Xplained Mini			
ATmega328PB_Xplained_Mini_TopLevel.SchDoc			

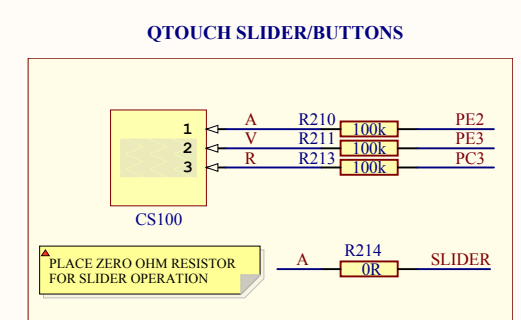
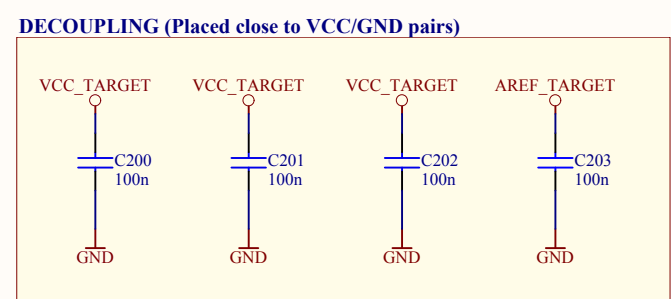
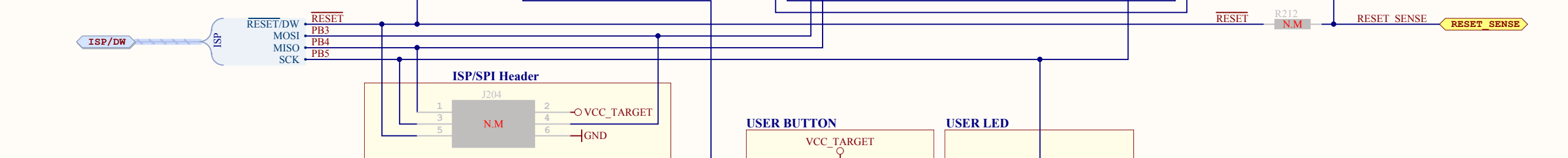
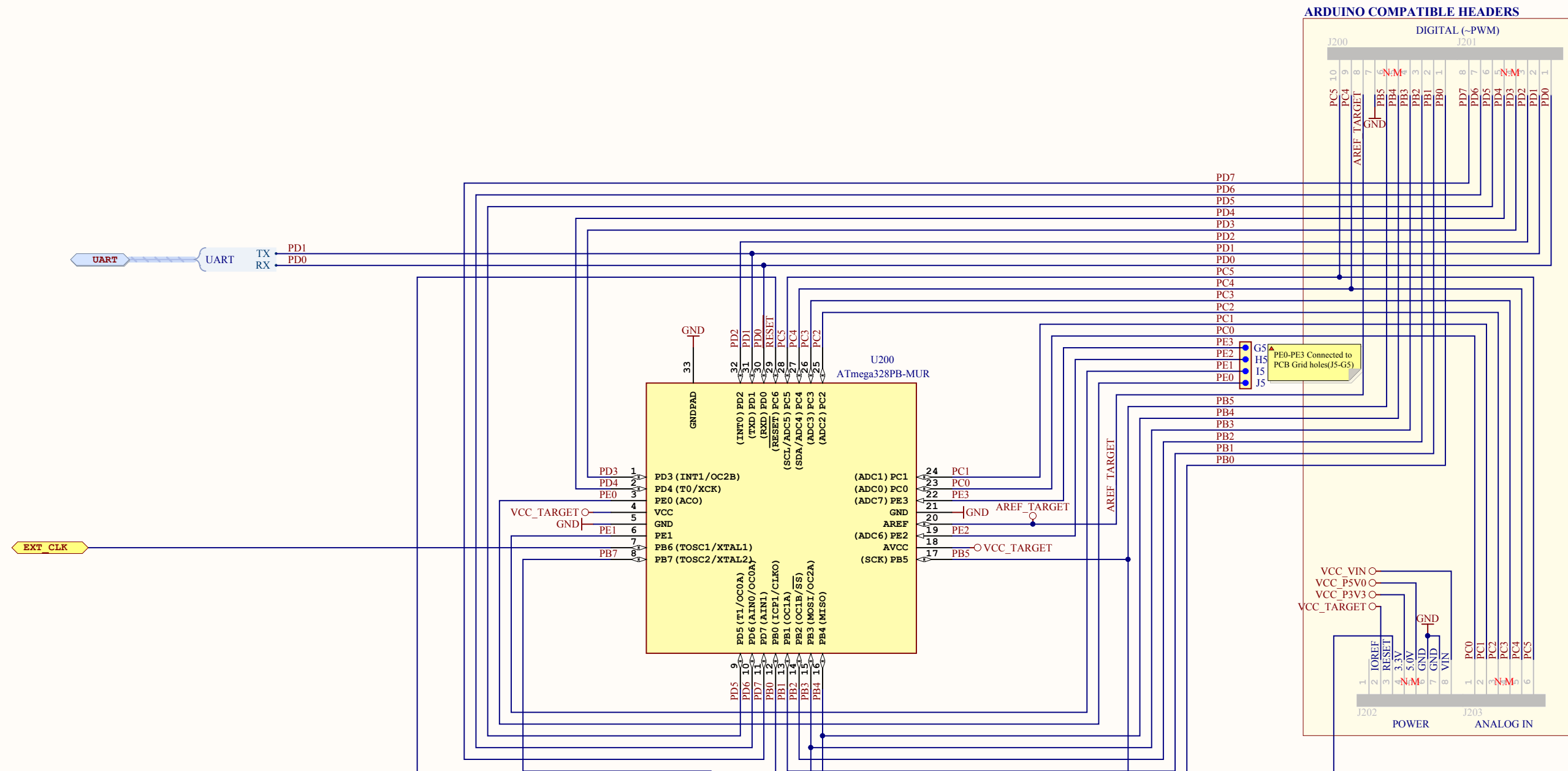

ATMEL Norway	*	
Vestre Rosten 79	*	
N-7075 TILLER	*	
NORWAY		
Date:	5/6/2015 10:19:58 PM	PAGE: 2 of 3
Document number:	A12-1030	Revision 3
TITLE: ATmega328PB Xplained Mini		
ATmega328PB_Xplained_Mini_Target.SchDoc		

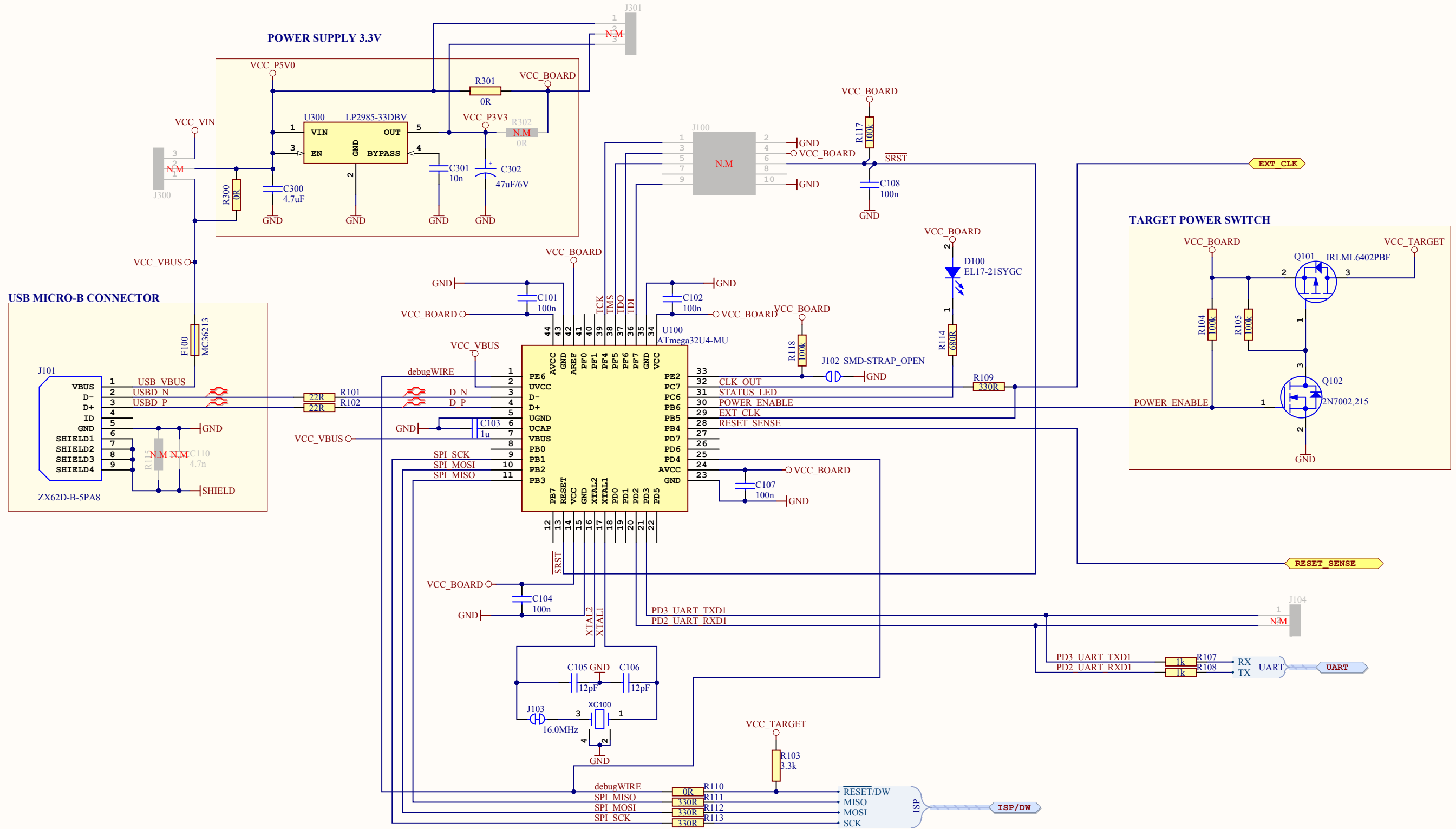

ATMEL Norway	*	 <small>Inabling Unlimited Possibilities</small>	
Vestre Rosten 79	*		
N-7075 TILLER	*		
NORWAY			
Date:	5/6/2015	10:19:58 PM	PAGE: 3 of 3
Document number:	A12-1030		Revision 3
TITLE: ATmega328PB Xplained Mini			
ATmega328PB_Xplained_Mini_Programmer.SchDoc			

Mechanical Dimensions

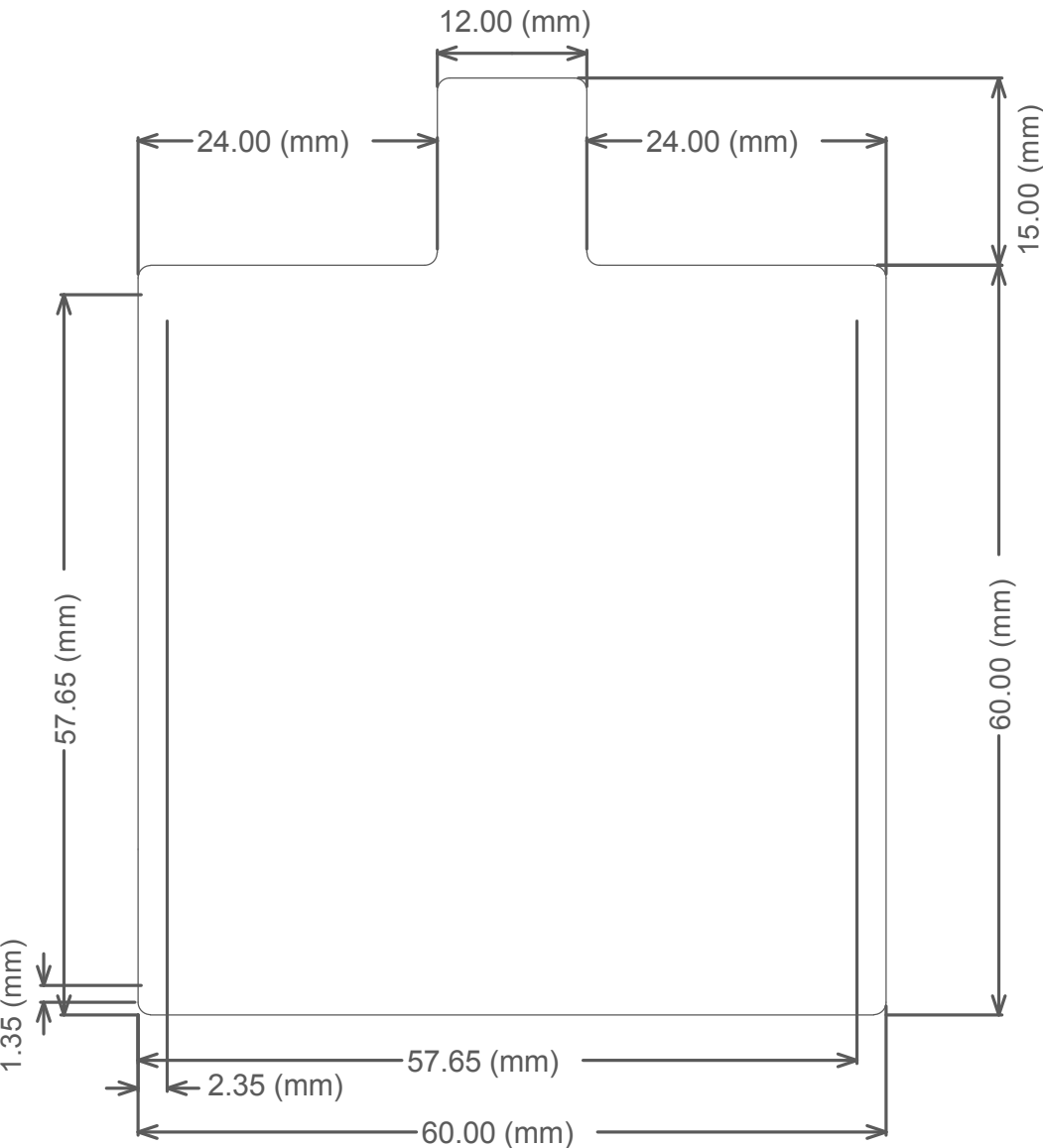

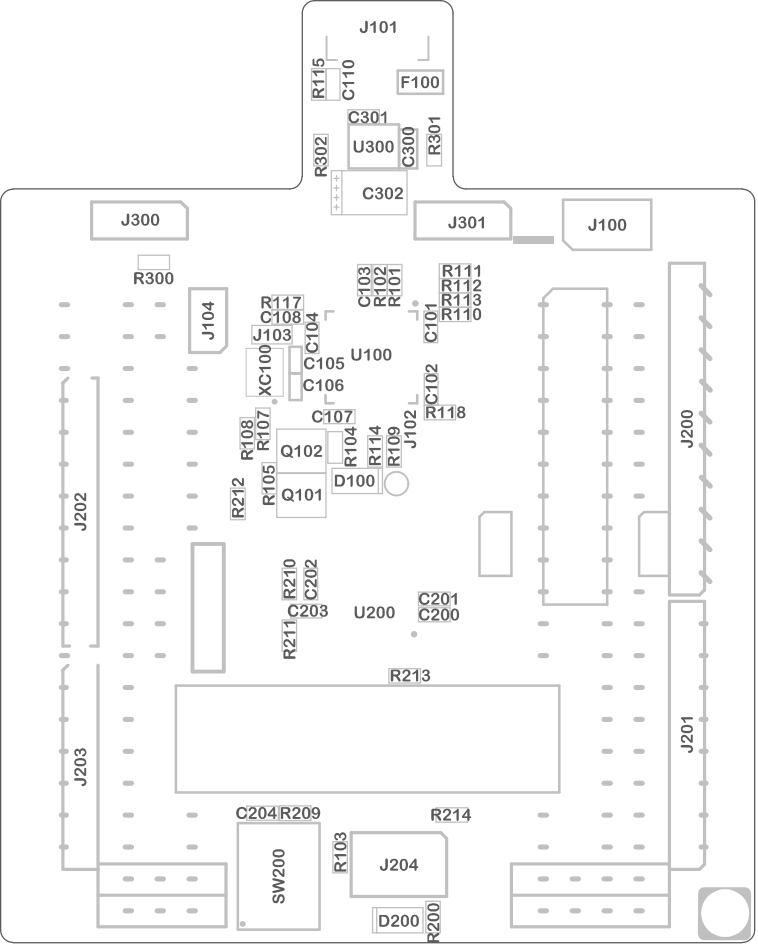

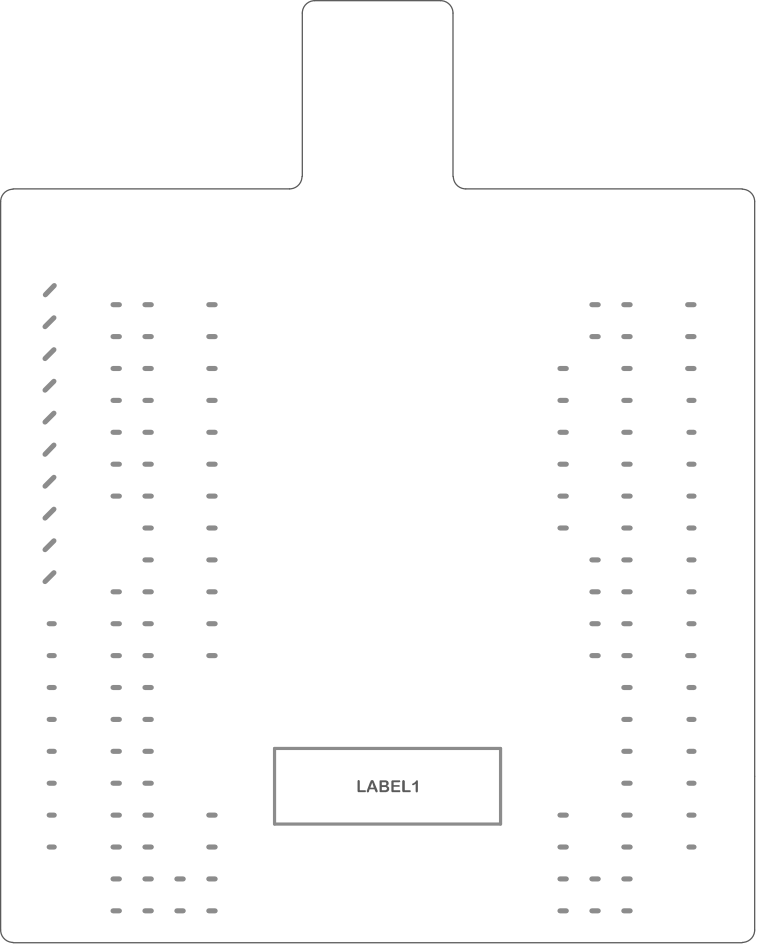

LABEL1

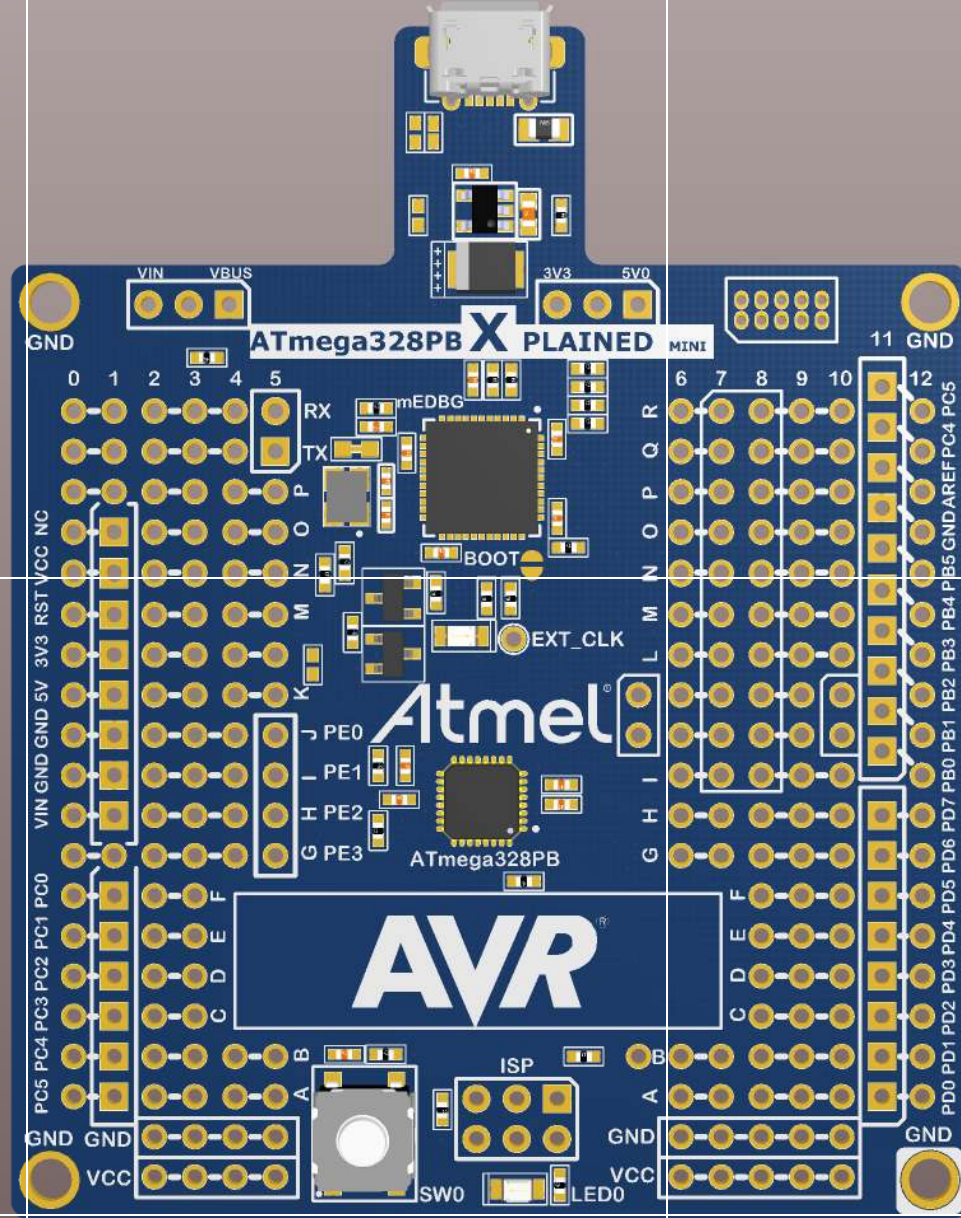

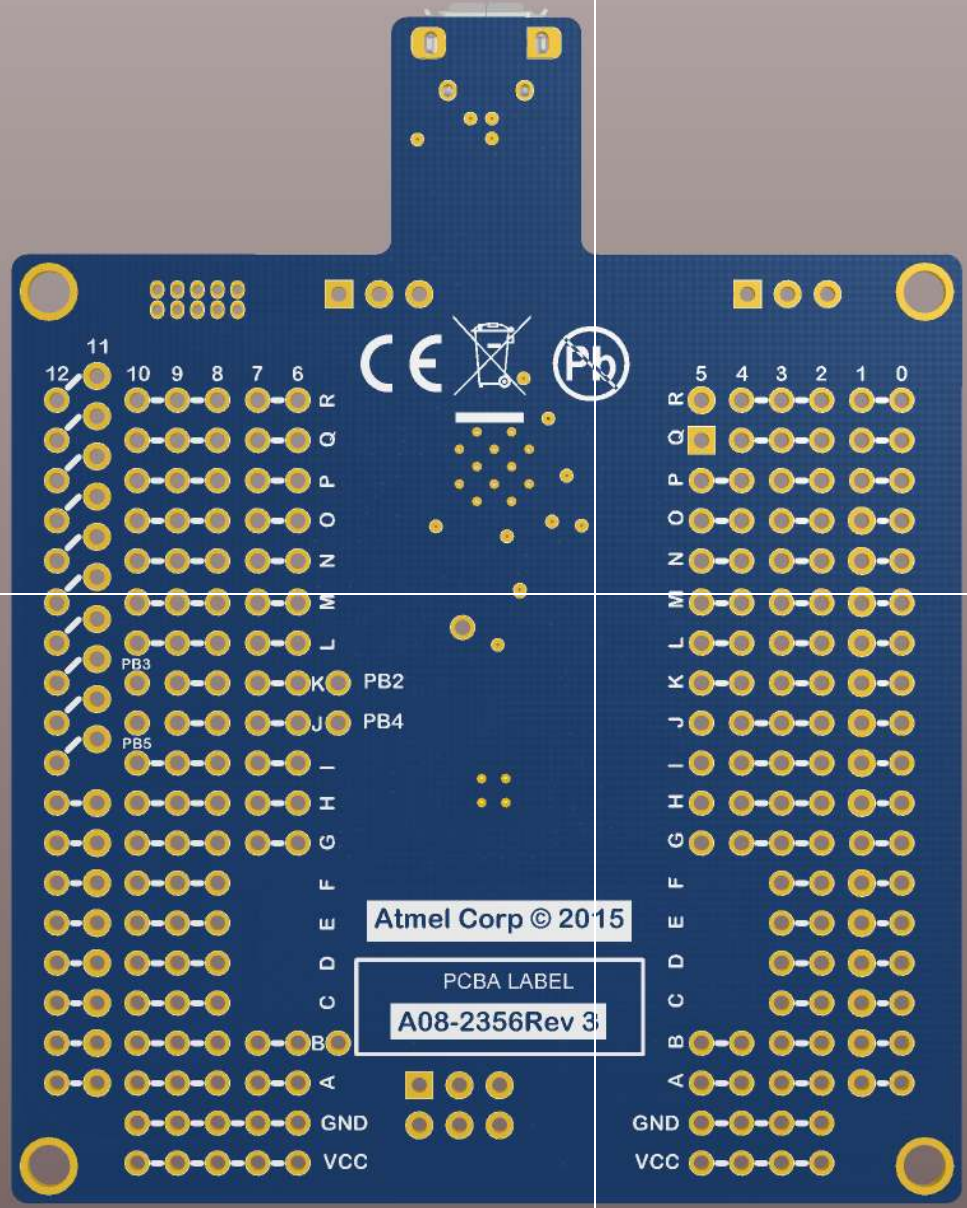

Atmel Corp © 2015

PCBA LABEL
A08-2356Rev 3

12 11 10 9 8 7 6



5 4 3 2 1 0

R
Q
P
O
N
M
L
K PB2
J PB4
I
H
G
F
E
D
C
B
A
GND
VCC

PB3
PB5

R
Q
P
O
N
M
L
K
J
I
H
G
F
E
D
C
B
A
GND
VCC

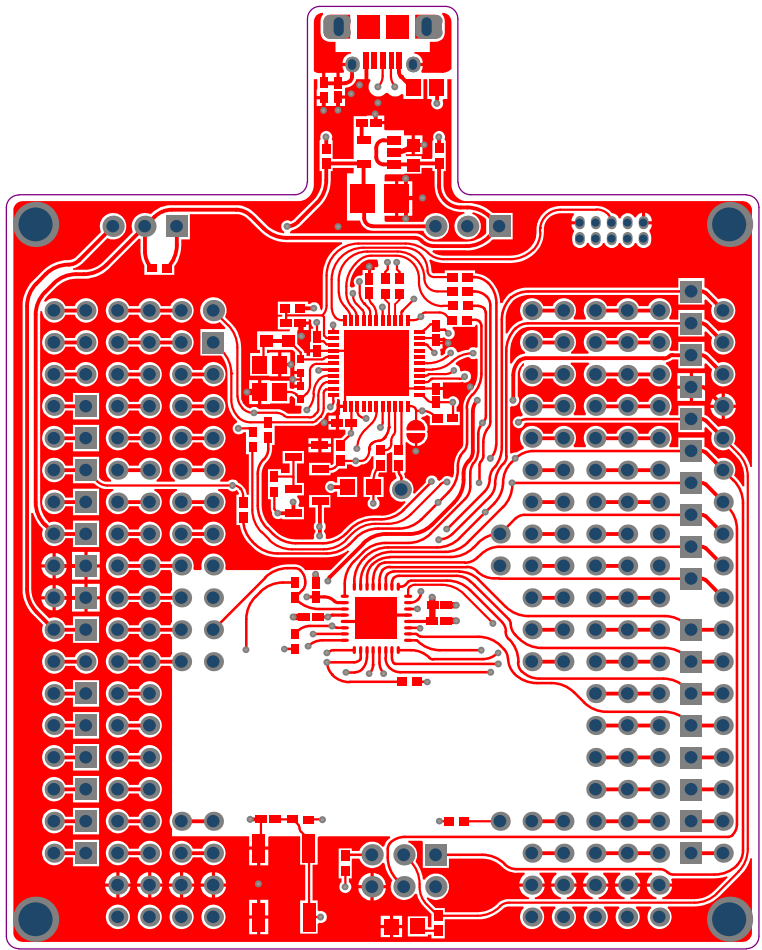

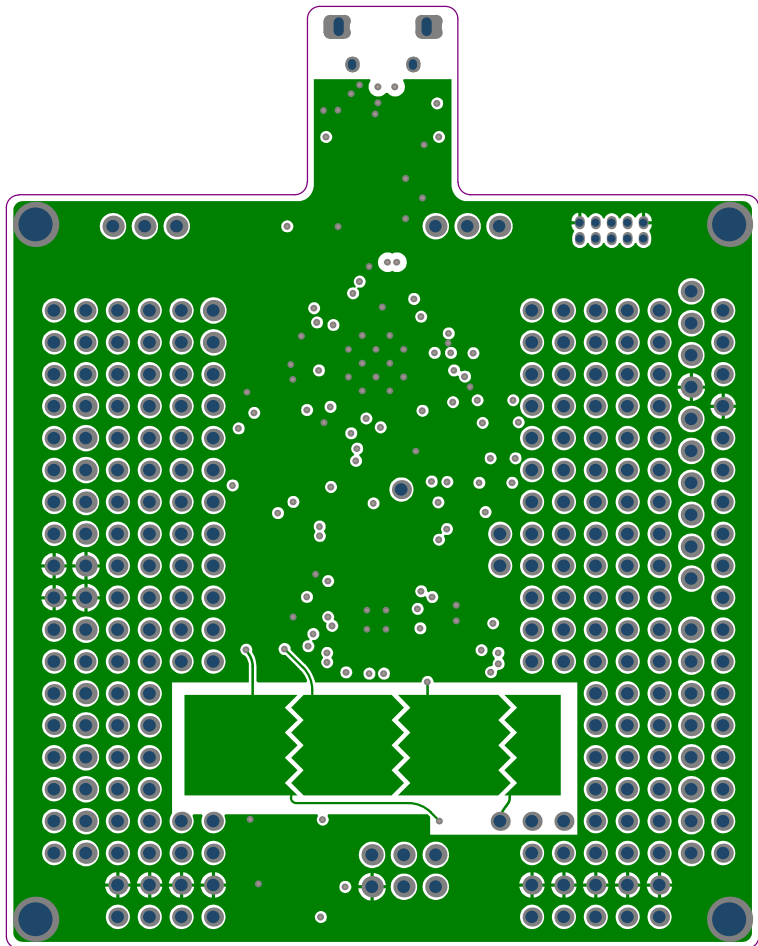

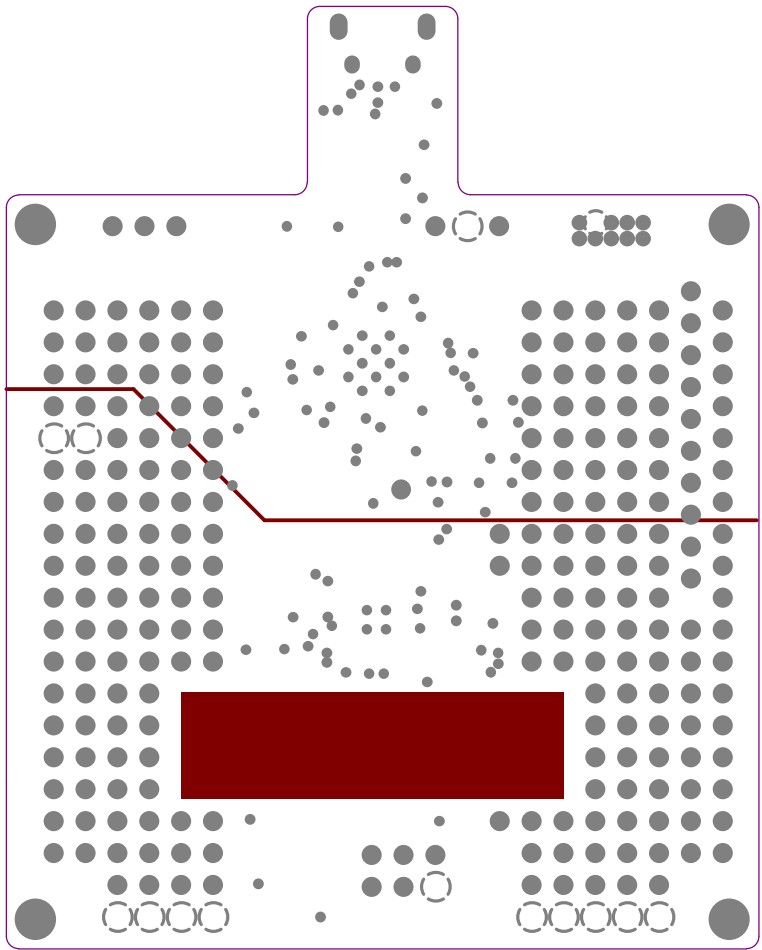

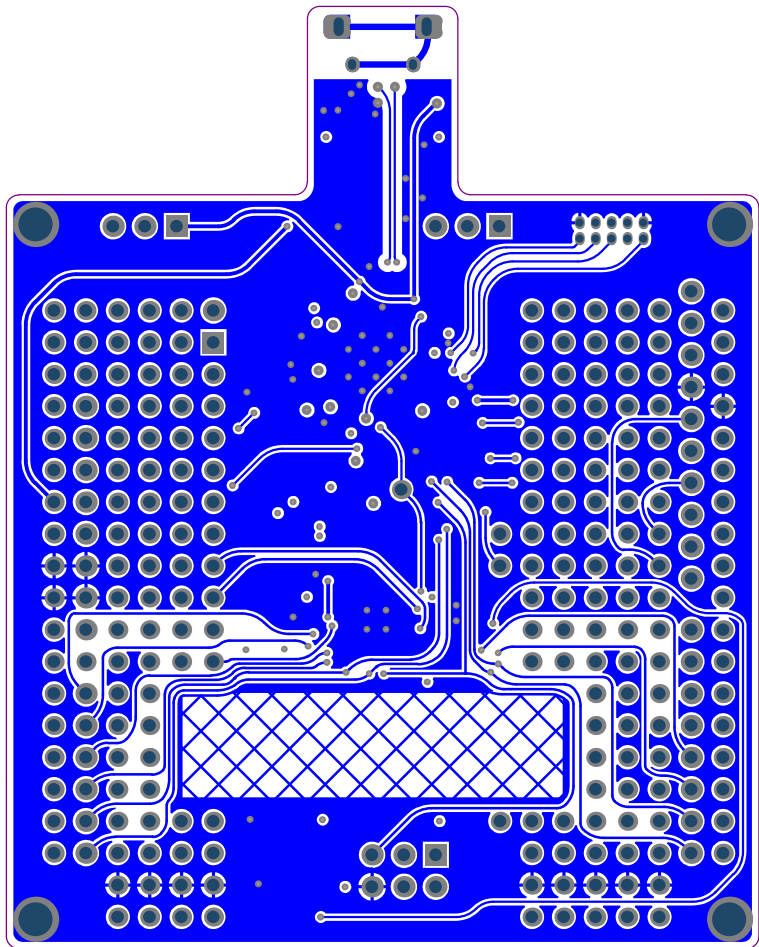

Component list

ATmega328PB Xplained Mini

Source Data From: ATmega328PB_Xplained_Mini.PrjPCB
 Project: ATmega328PB_Xplained_Mini.PrjPCB
 Variant: Default_assembly



Report Date: 5/6/2015 10:20:19 PM
 Print Date: <Parameter Curren <Parameter CurrentTime not found>

Fitted	Designator	Quantity	Value	Manufacturer	MPN	Description
Fitted	C101, C102, C104, C107, C108, C200, C201, C202, C203, C204	10	100n	Kemet	C0402C104K4RACTU	Ceramic capacitor, SMD 0402, X7R, 16V, +/-10%
Fitted	C103	1	1u	Kemet	C0402C105K9PAC	Ceramic capacitor, SMD 0402, X5R, 6.3V, +/-10% (de26942)
Fitted	C105, C106	2	12pF	Kyocera-elco	CM05CG120J50AH	Ceramic capacitor, SMD 0402, NPO, 50V, +/-5% (de19819)
Fitted	C300	1	4.7uF	AVX	0603ZD475KAT2A	Ceramic capacitor, SMD 0603, X6R, 10V, +/-10%
Fitted	C301	1	10n			Ceramic capacitor, SMD 0402, X7R, 25V, +/-10%
Fitted	C302	1	47uF6V	Kemet	T494B476M006A1	SMD tantalum capacitor, precision molded chip, ESR=0.5
Fitted	D100	1	EL17-21SYGC	Everlight	EL17-21SYGC	LED, Green, Wave length=575nm, SMD 0805, ±70°
Fitted	D200	1	EL17-21UYC/A3	Everlight	17-21UYC/S530-A3/TR8	LED, Yellow, Wave length=591nm, SMD 0805, ±70°
Fitted	F100	1	MC36213	Multicomp	MC36213	Resettable PTC fuse, I _n = 0.5A, I _t = 1.0A, 0805 package
Fitted	FW1	1	MEDBG firmware			MEDBG firmware
Fitted	J101	1	ZX62D-B-5PA8	HIROSE	ZX62D-B-5PA8	Micro USB B Connector, Standard SMT + DIP
Fitted	LABEL1	1	PCBA Label	ACT Logmark AS	505462	PCBA identification label PP Top White Gloss
Fitted	PCB1	1	ATmega328PB-XMINI.PCB			A Tmega328PB-XMINI.PCB documentation
Fitted	PCBADOC1	1	A09-2523.PCB.A Files			mega328PB Xplained Mini.PCB.A documentation
Fitted	Q101	1	IRLML6402PBF	International Rectifier	IRLML6402PBF	P-ch. MOSFET, -30V, -3.7A continuous RDS(ON)=0.050hm@VGS=4.5V, RDS(ON)=0.080hm@VGS=2.5V
Fitted	Q102	1	2N7002.215	IXP	2N7002.215	N-Channel MOSFET, 60V, 0.300A continuous, 1.2A Peak, RDS(ON) = 3.80hm@VGS=4.5V, VGS(th)<2.5V
Fitted	R101, R102	2	22R	Samsung	RC100SF22R0CS	Thick film resistor, SMD 0402, 1/16W, 1% (de33607)
Fitted	R103	1	3.3k			Thick film resistor, SMD 0402, 1/16W, 1%
Fitted	R104, R105, R117, R118, R209, R210, R211, R213	8	100k			Thick film resistor, SMD 0402, 1/16W, 1%
Fitted	R107, R108, R200	3	1k			Thick film resistor, SMD 0402, 1/16W, 1%
Fitted	R109, R111, R112, R113	4	330R			Thick film resistor, SMD 0402, 1/16W, 1%
Fitted	R110, R214, R300, R301	4	0R	(n/a)	RMCF0402ZT0R00	RES 0.0 OHM 1/16W 0402 SMD
Fitted	R114	1	680R			Thick film resistor, SMD 0402, 1/16W, 1%
Fitted	SW200	1	SKRAAKE010	ALPS	SKRAAKE010	6.2x6.2 mm SMD tact sw tch, same as A08-0091 but less force is needed
Fitted	TEST1	1	Test SW for A09-2523			Test SW for A09-2523, ATmega328PB Xplained Mini
Fitted	TESTDOC1	1	Xplained Mini Test Instructions			Fixture Test Instructions for Xplained Mini
Fitted	U100	1	ATmega32U4-MU	ATMEL	ATmega32U4-MU	ATmega32U4 QFN package
Fitted	U200	1	ATmega328PB-MJR			32k AVR with ADC/TWRS-232
Fitted	U300	1	LP2985-33DBV	Texas Instruments	LP2985-33DBV	LDO 3.3V 150mA SOT23-5 1.5% (cer. cap)
Fitted	XC100	1	16.0Mhz	Epson Toyocom	TSX-3225 16,000MF09Z-AC3	16MHz xTtal, 3.2 x 2.5 mm SMD, CL=9pF, 15PPM ESR=80ohm(Max)
Not Fitted	C110	0	4.7n			Ceramic capacitor, SMD 0402, X7R, 25V, +/-10% (de35287)
Not Fitted	J100	0	PIN HEADER 2x5	Garry	STL21-0730 G TT-10U	2x5 pin header, 1.27mm pitch, THM
Not Fitted	J104	0	HMTSW-102-23-F-S-237	SAMTEC	HMTSW-102-23-F-S-237	1x2 pin header, 2.54mm pitch, Pin-in-Paste THM
Not Fitted	J200	0	SSQ-110-21-F-S	SAMTEC	SSQ-110-21-F-S	1x10 receptacle pin header, low insertion force, 2.54mm pitch THM, Pin in Paste
Not Fitted	J201, J202	0	SSQ-108-21-F-S	SAMTEC	SSQ-108-21-F-S	1x8 receptacle pin header, low insertion force, 2.54mm pitch THM, Pin in Paste
Not Fitted	J203	0	SSQ-106-21-F-S	SAMTEC	SSQ-106-21-F-S	1x6 receptacle pin header, low insertion force, 2.54mm pitch THM
Not Fitted	J204	0	MTSW-103-08-L-D-276	SAMTEC	MTSW-103-08-L-D-276	2x3 pin header, 2.54 mm pitch, THM
Not Fitted	J300, J301	0	HMTSW-103-23-F-S-237	SAMTEC	HMTSW-103-23-F-S-237	1x3 pin header, 2.54mm pitch, Pin-in-Paste THM, 1mm hole
Not Fitted	R115	0	1M			Thick film resistor, SMD 0402, 1/16W, 1%
Not Fitted	R212, R302	0	0R	(n/a)	RMCF0402ZT0R00	RES 0.0 OHM 1/16W 0402 SMD

Approved	Notes
----------	-------